

3" Recessed Housing

MODEL ODH2-3IA

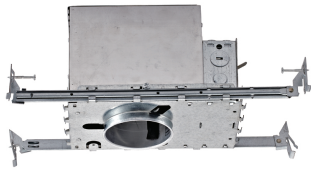

WARNING

WARNING — THE INSTALLATION MUST BE CARRIED OUT BY A QUALIFIED ELECTRICIAN.

1. Shut off electrical power at the fuse or circuit breaker panel
2. Most dwellings built before 1985 have supply wire rated +60°C
3. Properly position a sturdy and stable step ladder high enough to reach the ceiling safely
4. This recessed housing is suitable for insulated ceilings for total contact covered with insulation

CAUTION

PLEASE READ INSTRUCTION BEFORE COMMENCING INSTALLATION AND RETAIN FOR FUTURE REFERENCES. Electrical products can cause death or injury, or damage to property. If in any doubt about the installation or use of this product, consult a competent electrician.

INSTALLATION GUIDE

Bar Hangers

1. Install hanger bars to fixture — be sure end tab is facing outward (see Fig.2)

Installing Fixture to Ceiling

1. Joists type ceilings — extend bar hangers to fit between joist and position fixture temporarily by hammering nail on bars into the joists. Hangers should be leveled with bottom of joists (see Fig.3)
2. Suspended (T-bar) ceilings — extend bar hangers 1" past T-bars then rest fixture on t-bars. Secure fixture to t-bars with wire see (see Fig.4)

Install Trim Assemblies

1. Insert trim into housing — push upward fully and pressure springs will hold trim in place (see Fig. 5)

Electrical Connection

1. Most dwellings built before 1985 have supply wire rated +60°C. Consult a qualified electrician before installing
2. Junction box contains three wires:
a BLACK (live +), WHITE (neutral -), and bare ground. **MAKE SURE TO CONNECT WHITE TO WHITE AND COLOURED OR BLACK TO BLACK** (see Fig.6)
3. After completing the wiring (being sure the wires are placed within wiring box). Snap wiring box cover closed

Grounding

For Romex or 3 wire BX, flexible armour cable installations, attach supply ground lead to bare copper ground lead or ground screw in wiring box mount or mounted on plaster frame. Local electrical codes should be consulted to determine acceptable installation — conduit Romex or flexible Armour cable.

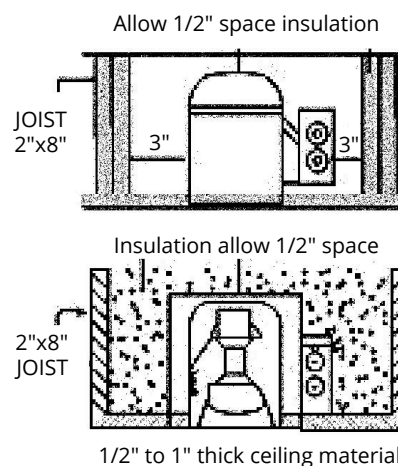

Fig.1

Non-IC Housing: Insulation must not be used in direct contact with fixture. Insulation needs to be at least 3" away from the fixture

IC Housing: Can be installed in direct contact with insulation

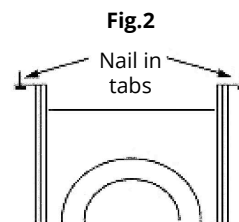

Fig.2

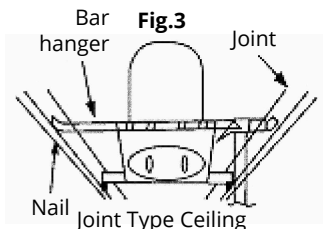

Fig.3

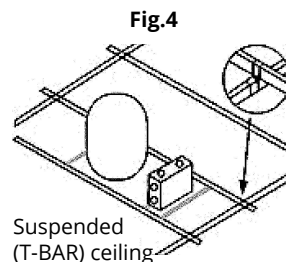

Fig.4

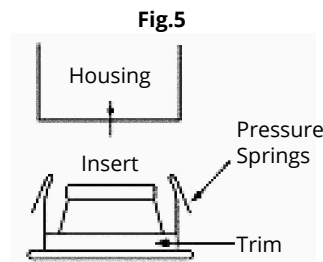
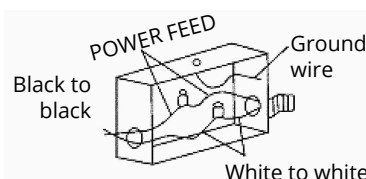

Fig.5

Fig.6
Ground screw or ground wire



Wiring Connection in J-box for low voltage

3" Recessed Housing

MODEL ODH2-3IA

INSTALLATION GUIDE

1. Bar Hangers

Insert bar hangers into the slots on the plaster frame (Fig.A). Position bar hangers so that nail in tabs point away from housing or point down to ceiling

2. Fasten Fixture to Ceiling

Joist-type ceilings — extend bar hangers to fit between joists. Position fixture temporarily by hammering "nail-in" tabs into joists (Fig.2) then secure permanently with nails. Hangers should be level with bottom of joists. Suspended (T-bar) ceilings — extend bar hangers 1" past T-bars then rest fixture on T-bars. Secure fixture to T-bars with wire (see Fig.C)

3. Electrical Connection

Junction box contains two wires, a BLACK (live +) and a white (neutral -), which must be spliced to the house current feed wires. Make sure to splice WHITE to WHITE and coloured or BLACK to BLACK. After splicing has been completed, tuck splices carefully into junction box and replace cover (see Fig.D)

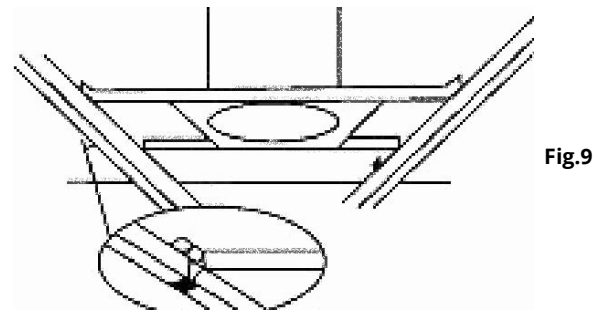
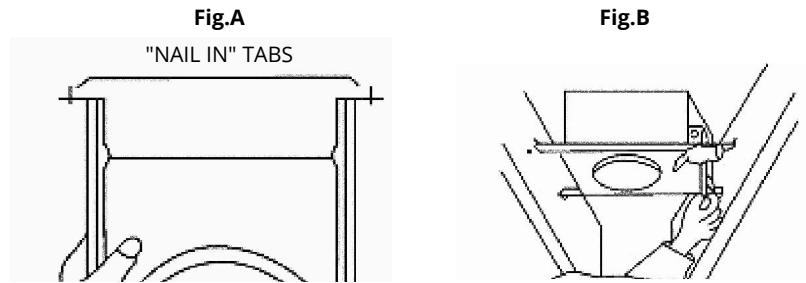

Air Tight Installation Instructions

After installing the housing in the ceiling. Seal opening of ceiling and around the edge of plaster frame by gasket supplied in J-box. Then put lamp and trim into the fixture.

Grounding

For Romex or 3 wiper Bx, flexible Armour cable installations attach supply ground lead (green) to bars copper ground lead or ground screw in wiring box mount or mounted on plaster frame. Local electrical codes should be consulted to determine acceptable installation-conduit Romex or flexible Armour cable.

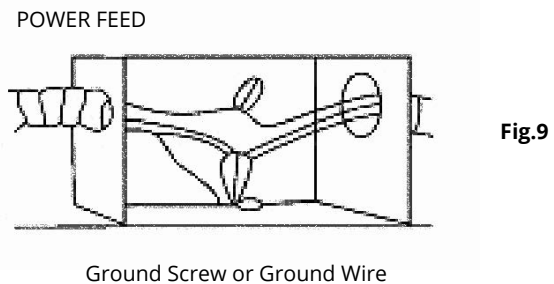

ORTECH reserves the right to modify at any time, without notice, any or all of our product's features, designs, components and specifications to meet market changes.