



HIGHLIGHTS

- Maximum 15W constant voltage phase TRIAC dimmable class 2 Driver for LED lighting and moving sign applications
- Offers strong compatibility, flicker-free dimming as well as high efficiency: up to 80%
- Integrated junction box for hard wire installation

SPECIFICATIONS

Model	OT-15D
Input Voltage	100-130V AC
Output Voltage	12V DC
Maximum Wattage	15W
Amps	1.25A
Dimmable	Yes
Grade of Protection	IP 20
Frequency Range	47-63Hz
Power Factor	0.6 (Full loading)
Efficiency (Typ.)	80%
AC Current (Max.)	0.33A
Short Circuit	Hiccup mode, recover automatically after fault condition is removed
Over Loading	≤ 120%
Operating Temperature	-25°C ~ +45°C
Warranty	5 years

MODEL OT-15D

DIMENSIONS

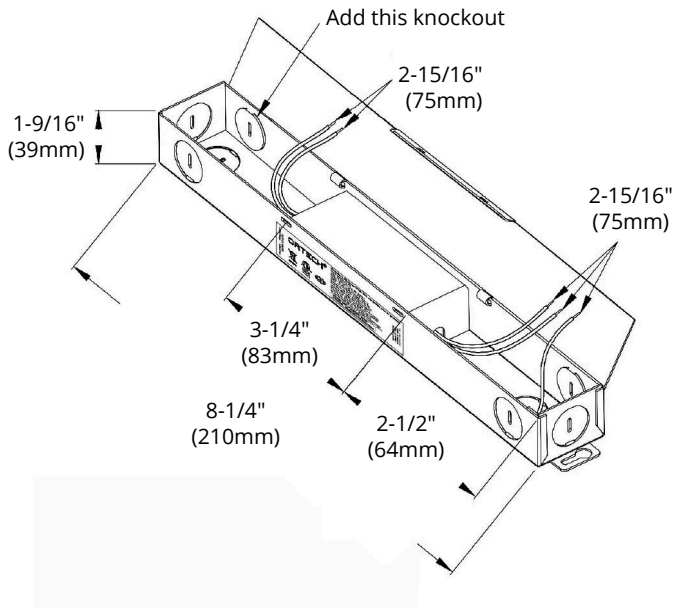

Important Reminder

- All parameters if NOT specially mentioned are measured at 120V AC input, rated load and +25°C of ambient temperature
- To extend the driver's lifespan, please reduce the loading at lower input voltage
- Loading should be 5%-100%

Dimming Operation

- The Pulse-Width Modulation (PWM) of output voltage can be adjusted through input terminal of the AC phase line (L) by connecting a TRIAC dimmer
- Usually matching with leading edge / Forward Phase TRIAC Dimmers (can be customized as a driver only matching trailing edge / reverse phase TRIAC Dimmers if needed)
- Please try to use dimmers with power at least 2.5 times as the output power of the driver
- For Forward phase, magnetic low voltage and TRIAC dimmers

WIRING DIAGRAM

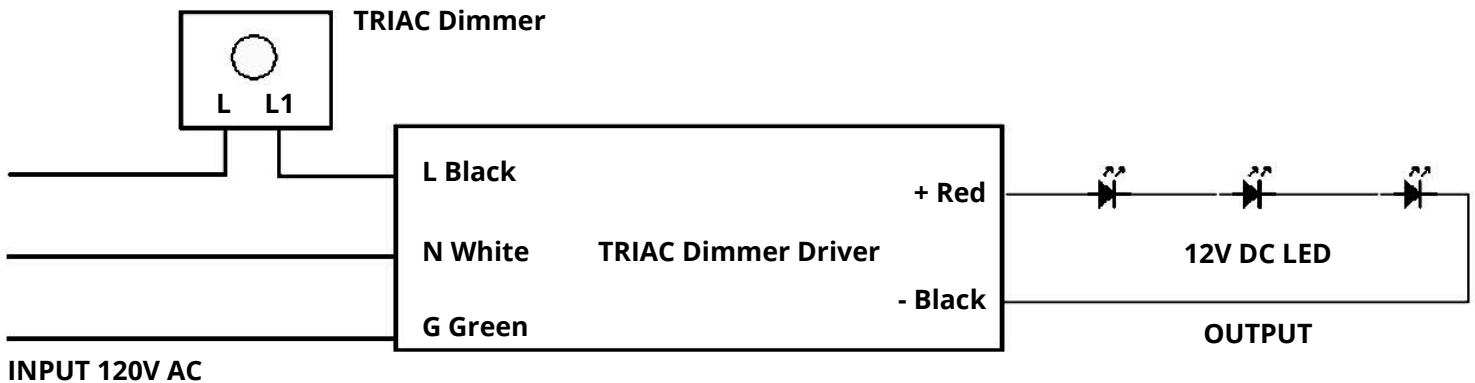

ORTECH reserves the right to modify at any time, without notice, any or all of our product's features, designs, components and specifications to meet market changes.

Reference	QTY.	Remarks	Project:
			Location:
			Architect:
			Engineer:
			Contractor:
			Submitted by:
			Date: