

Mounting Plate

MODEL PLATE 2-HB

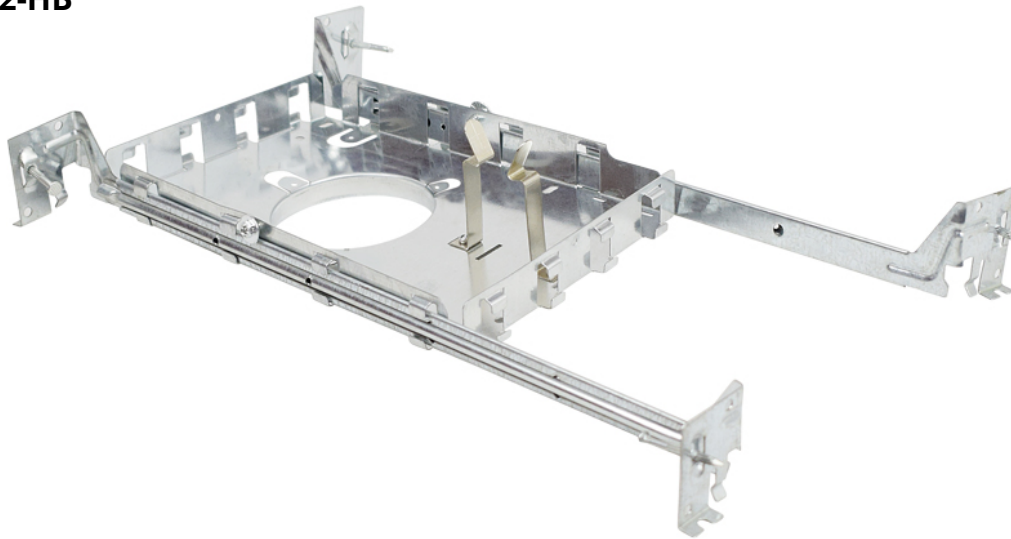

HIGHLIGHTS

Galvanized steel mounting plate with hanger bars for ORTECH 2" LED slim lights

- Hanger bar install in longer side
- For 2" LED slim light with curved lip

SPECIFICATIONS

Model	PLATE 2-HB
Hole Size	Ø 2-5/8" (67 mm)
Material	Galvanized steel
Hanger Bar Installation Type	Four way

DIMENSIONS

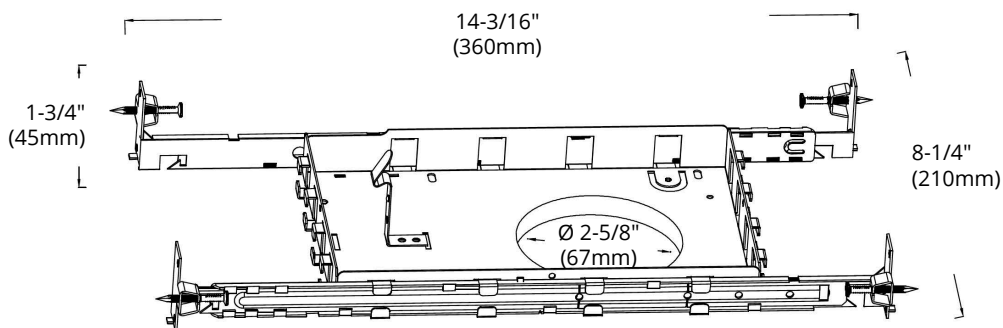

Reference	QTY.	Remarks	Project:
			Location:
			Architect:
			Engineer:
			Contractor:
			Submitted by:
			Date:

ORTECH reserves the right to modify at any time, without notice, any or all of our product's features, designs, components and specifications to meet market changes.