

MODEL SLIM4-3CCT

WARNING

WARNING — THE INSTALLATION MUST BE CARRIED OUT BY A QUALIFIED ELECTRICIAN.

1. LED Slim Lights are suitable for indoor use only. DO NOT use outdoors.
2. Please keep the LED Slim Lights away from any corrosive substance, and please use dry cloth when you clean it.
3. LED Slim Lights can only be installed by a qualified electrician.
4. Before installation or maintenance, please disconnect the power to prevent electric shock.



CAUTION

PLEASE READ INSTRUCTION BEFORE COMMENCING INSTALLATION AND RETAIN FOR FUTURE REFERENCES.

Electrical products can cause death or injury, or damage to property.

If in any doubt about the installation or use of this product, consult a competent electrician.

INSTALLATION GUIDE

Tools Required

- Saw
- Measuring Tape
- Electrical Wiring (use type and gauge suitable for application to connect the fixtures)

PRE-INSTALLATION

1. Turn power OFF from the electrical panel before starting installation.
2. Locate a suitable position to plate the fixture and open in accordance to the cut-hole dimensions (refer to Hole Cut Table for appropriate size).
3. Run electrical wire from the switch (power supply) through the mounting hole-use NMD90 Romex or BX cable.

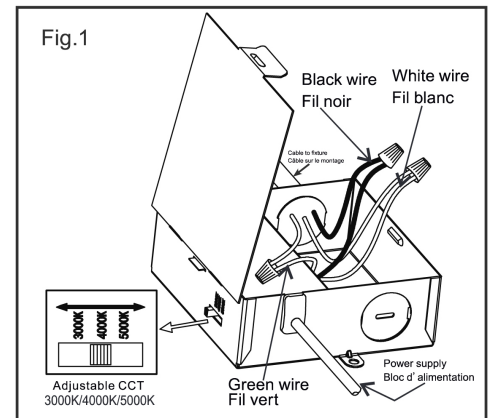

DRIVER WIRING

1. Open the driver box swing cover and remove the appropriate knockout (s).
2. Insert the electrical supply cable through the knockout and secure with a cable connector (sold separately).
3. Using wire nuts, connect green ground wire of cable to green wire on box. Connect white wire of cable to white wire of box. Connect black wire of cable to black wire of box. (Fig.1)
4. Place all wiring and connections back in to the box and close the cover.
5. Insert driver box through the mounting hole. (Fig.2) New construction applications: driver box shall be firmly secured to studs, joists, or similar fixed structural units. Remodel applications: Do not require the driver box to be firmly secured after the mounting plates, studs, joists, or structural units have been concealed.

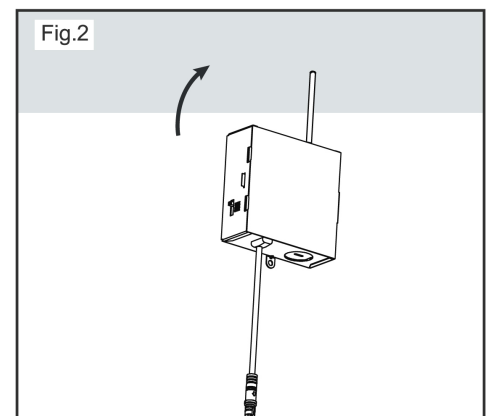

ORTECH reserves the right to modify at any time, without notice, any or all of our product's features, designs, components and specifications to meet market changes.

INSTALLATION GUIDE

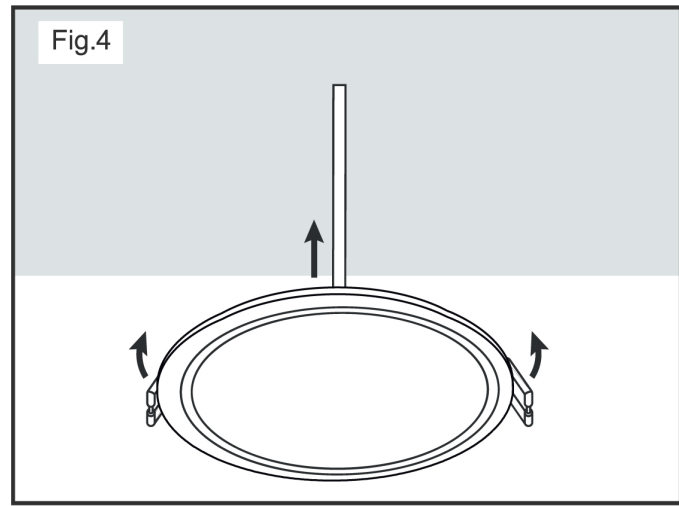
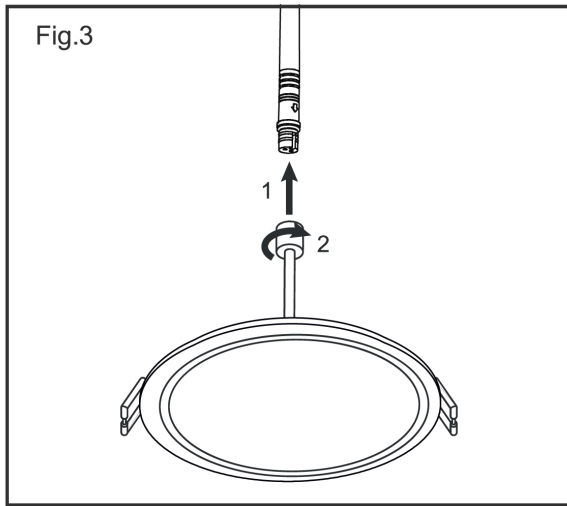

FIXTURE INSTALLATION

1. Connect the fixture to the driver box by inserting and twisting the male/female connectors. (Fig.3)
2. Push spring loaded clips on the fixture upwards and insert fixture base in to the mounting hole. Release the clips and fixture will be pulled flush to the ceiling. (Fig.4)
3. Once assembly is complete, turn on power to confirm fixture is working properly.

Hole Cut Size

3 inch round	Ø3-1/8"(78mm)
4 inch round	Ø4-1/4"(108mm)
6 inch round	Ø6-1/4"(158mm)

ORTECH reserves the right to modify at any time, without notice, any or all of our product's features, designs, components and specifications to meet market changes.