

LED CANOPIES

CNP40-3CCT+W | CNP100-3CCT+W

WARNING

WARNING — THE INSTALLATION MUST BE CARRIED OUT BY A QUALIFIED ELECTRICIAN.

- Please keep the LED Canopies away from any corrosive substance, and please use dry cloth when you clean them
- LED Canopies can only be installed by a qualified electrician
- Before installation or maintenance, please disconnect the power to prevent electric shock

APPLICATION NOTICE

- For your safety, this fixture **MUST** be wired in accordance to electrical codes and ordinances
- **DO NOT** open the light fixture and the side plates of driver — no serviceable part inside
- **DO NOT** use any other driver except the ones advised by the supplier
- **DO NOT** connect multiple fixtures to one driver

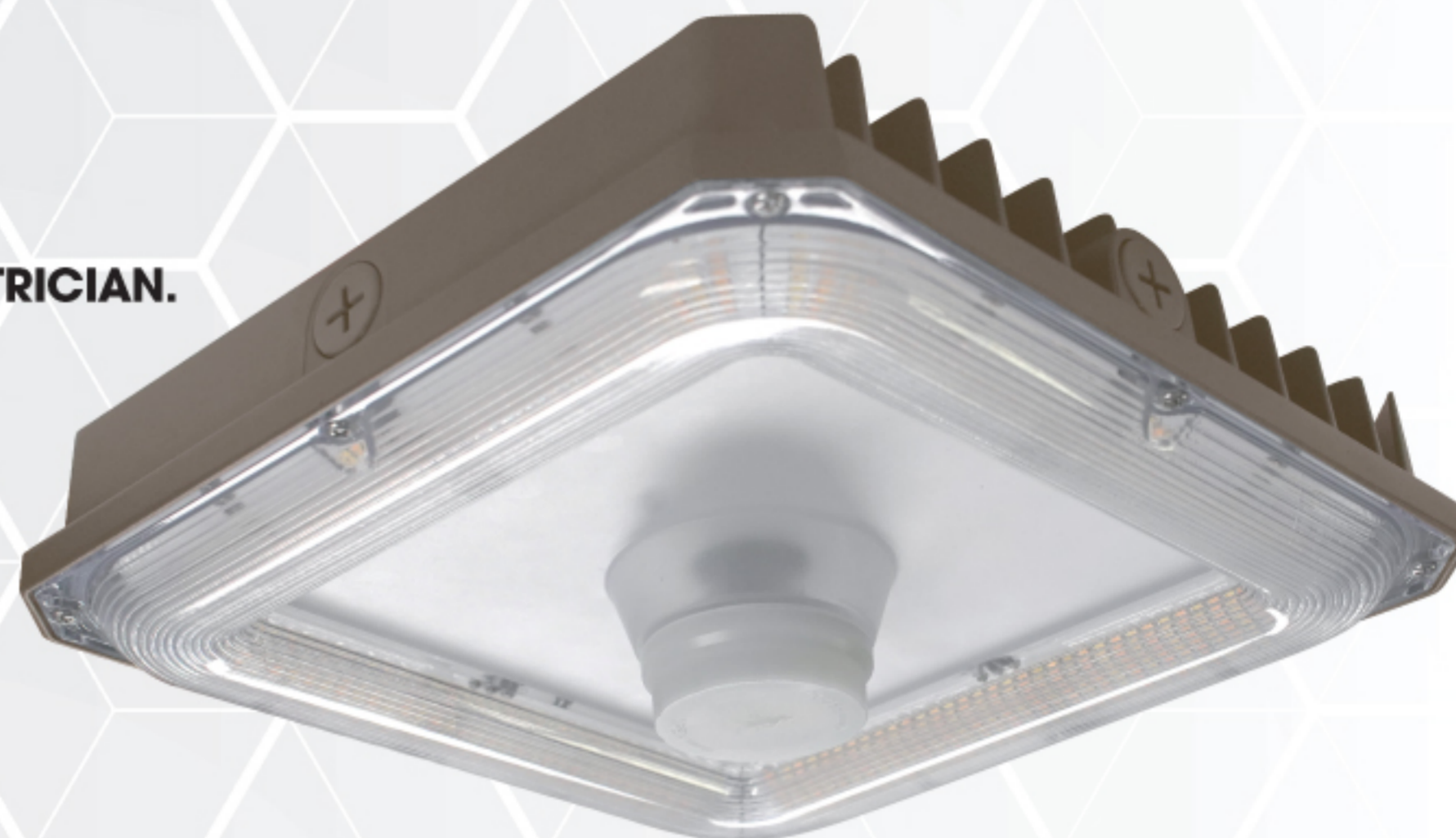

CAUTION

PLEASE READ INSTRUCTION BEFORE COMMENCING INSTALLATION AND RETAIN FOR FUTURE REFERENCES.

Electrical products can cause death or injury, or damage to property. If in any doubt about the installation or use of this product, consult a competent electrician.

CEILING INSTALLATION

1. Loosen the screw to take off the mounting plate from the lamp.

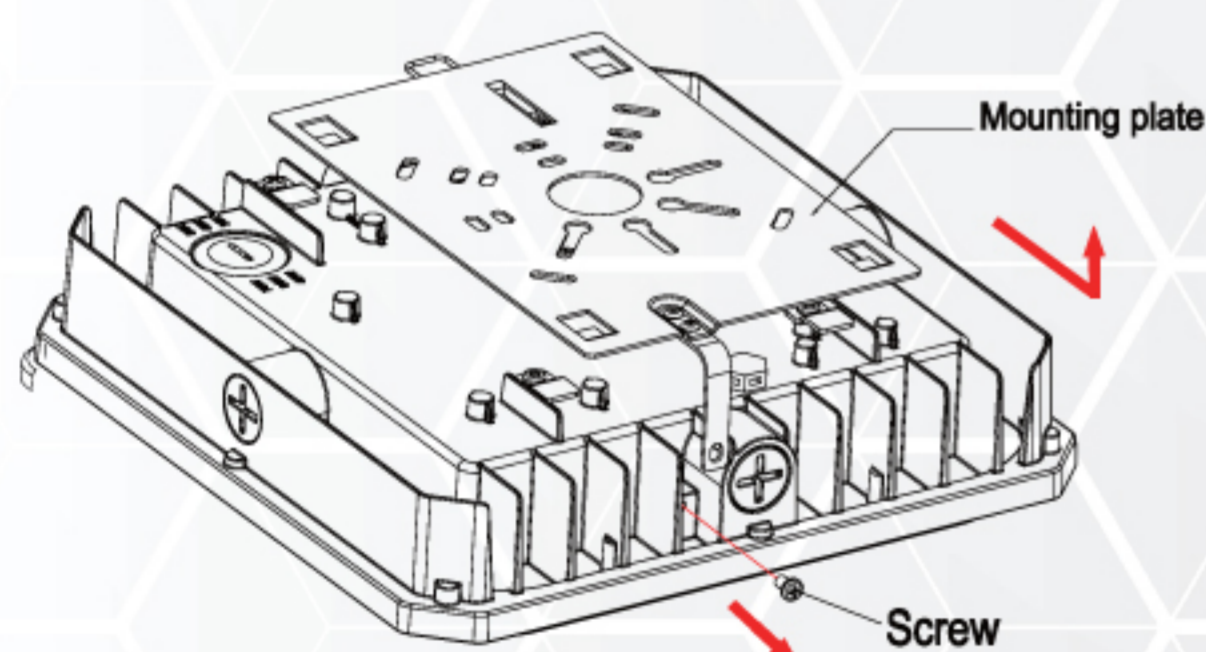

2. Screw the mounting plate to the ceiling.

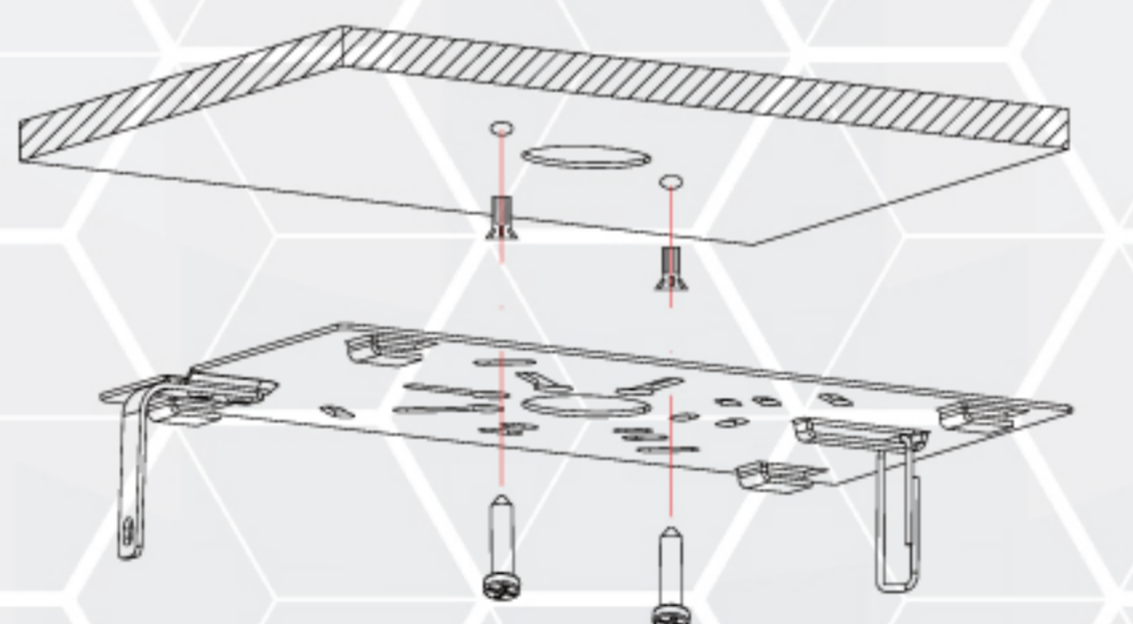

3. Hang the lamp on the ring so as to connect wires with terminal caps.

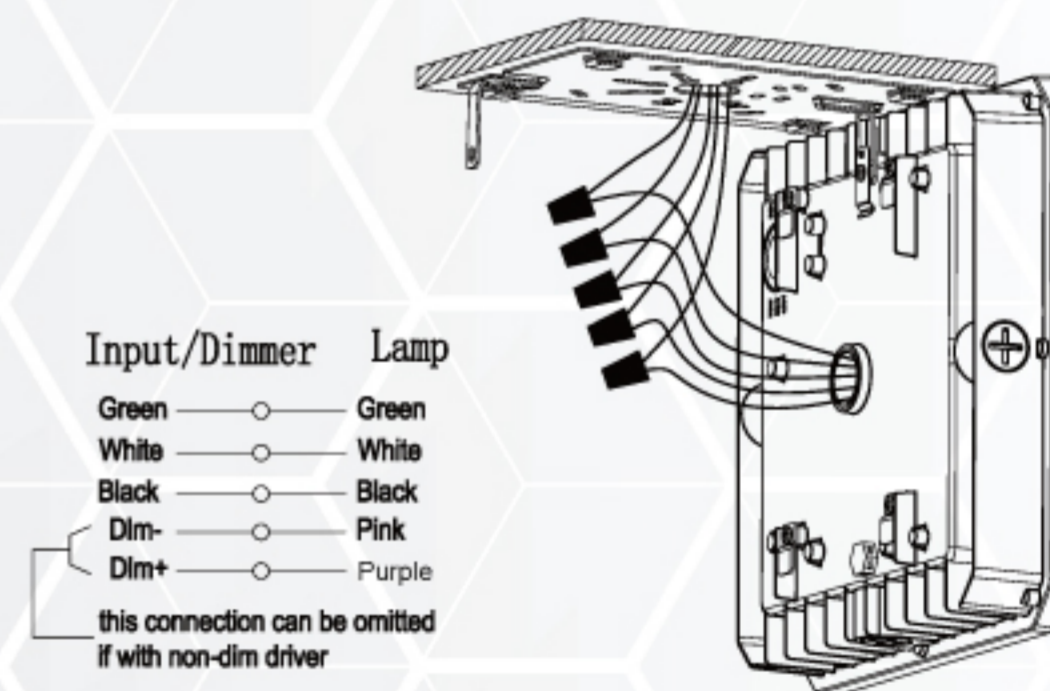

4. Hook up lamp on the mounting plate.

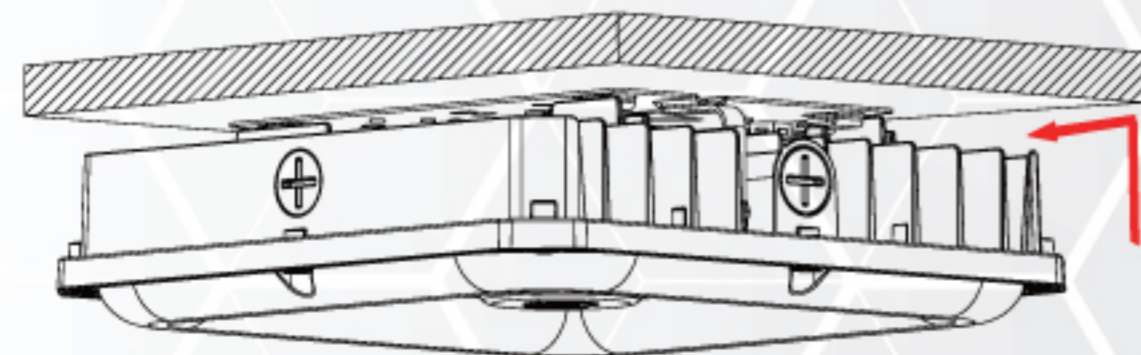

5. Secure the screw. Installation completed.



POLE-PENDANT INSTALLATION

1. Connecting wires with terminal caps as picture shows.

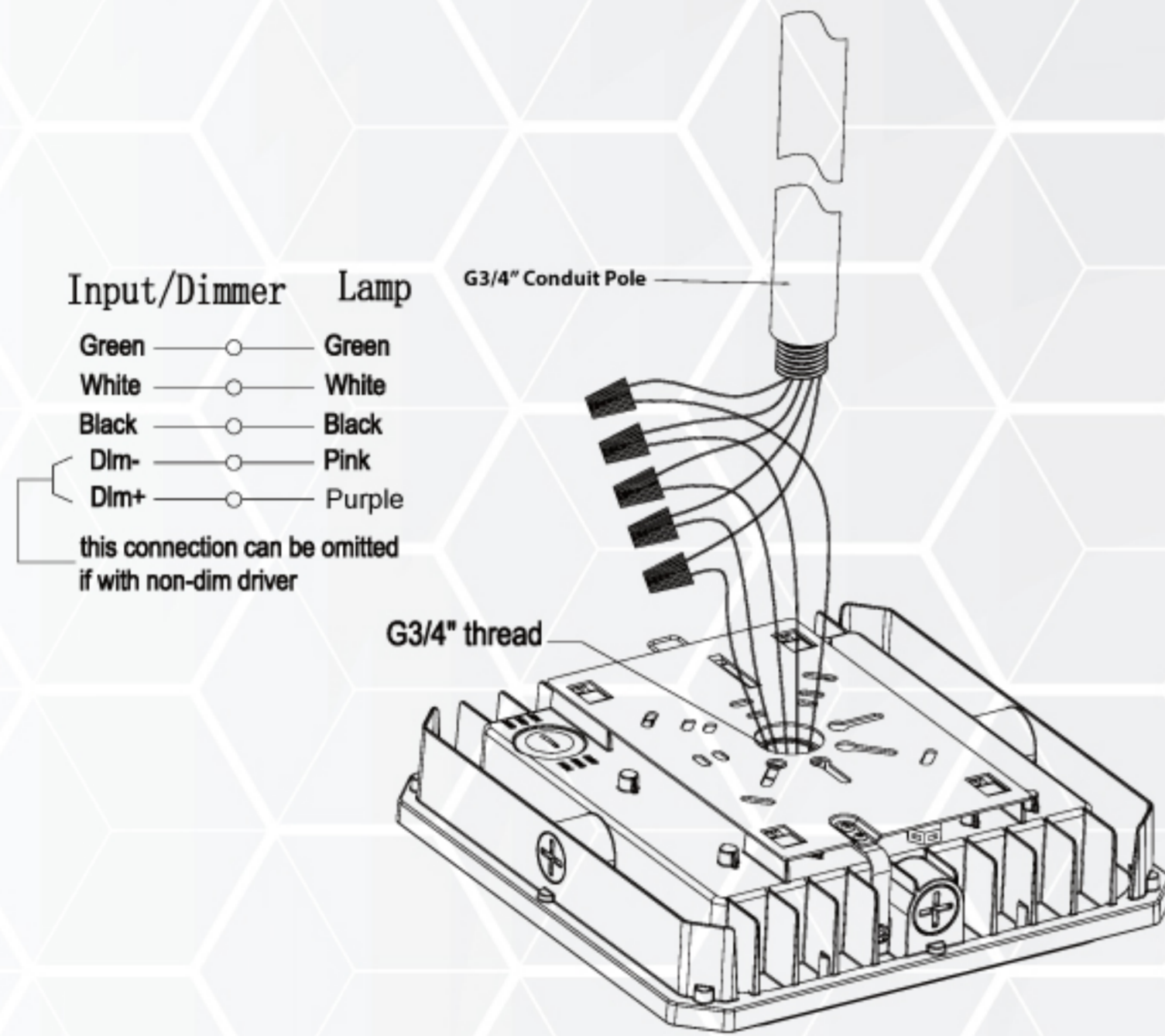

2. Rotating the conduit pole to make it fixed with lamp. Installation completed.

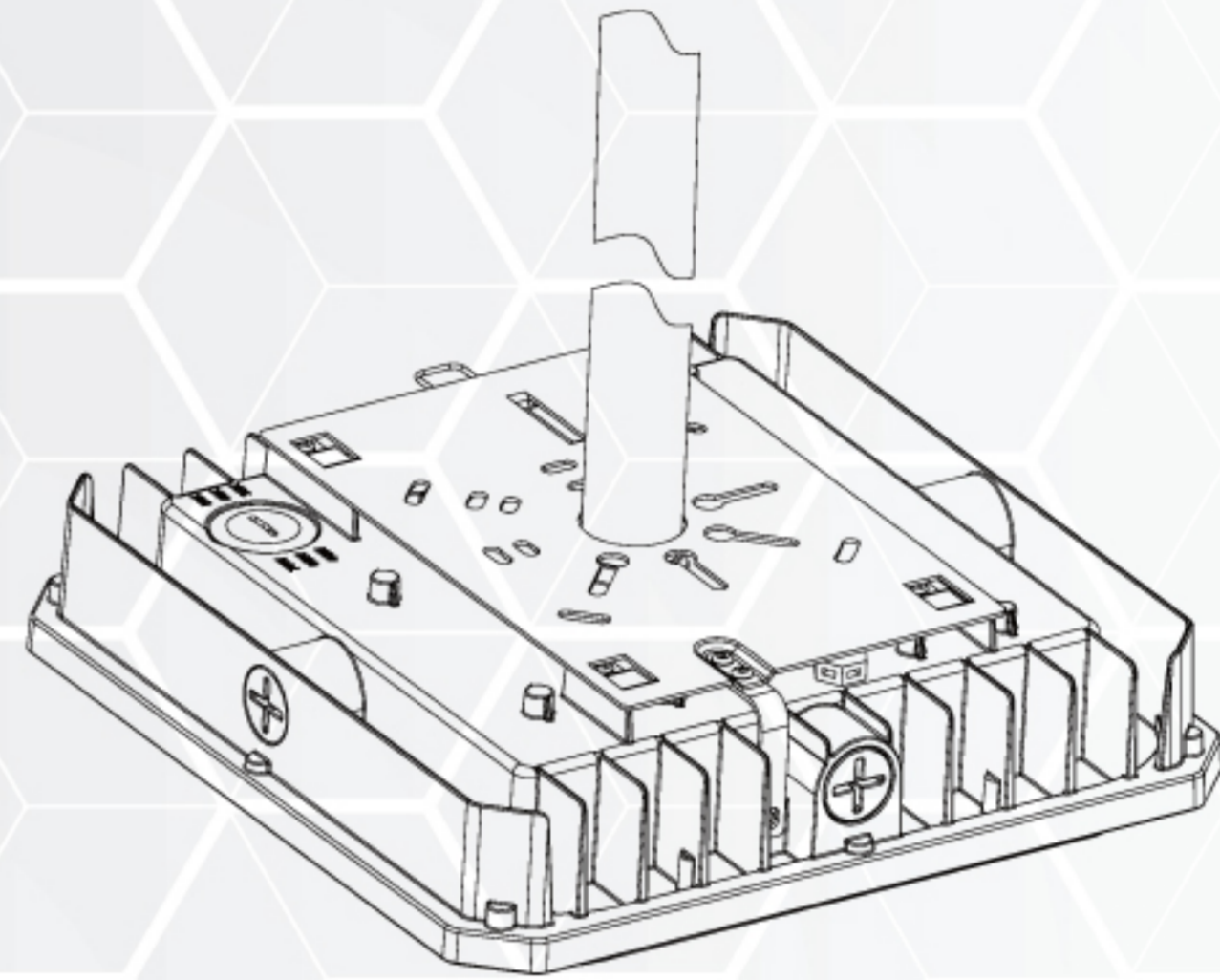

**** NOTE: ORTECH does not offer any G3/4" Conduit Pole, however this will be compatible with any standard 3rd party version ****

PLUG SENSOR INSTALLATION

1. Unscrew the PC cap on the lampshade counter-clockwise with a flat-head screwdriver on the lamp which already installed.

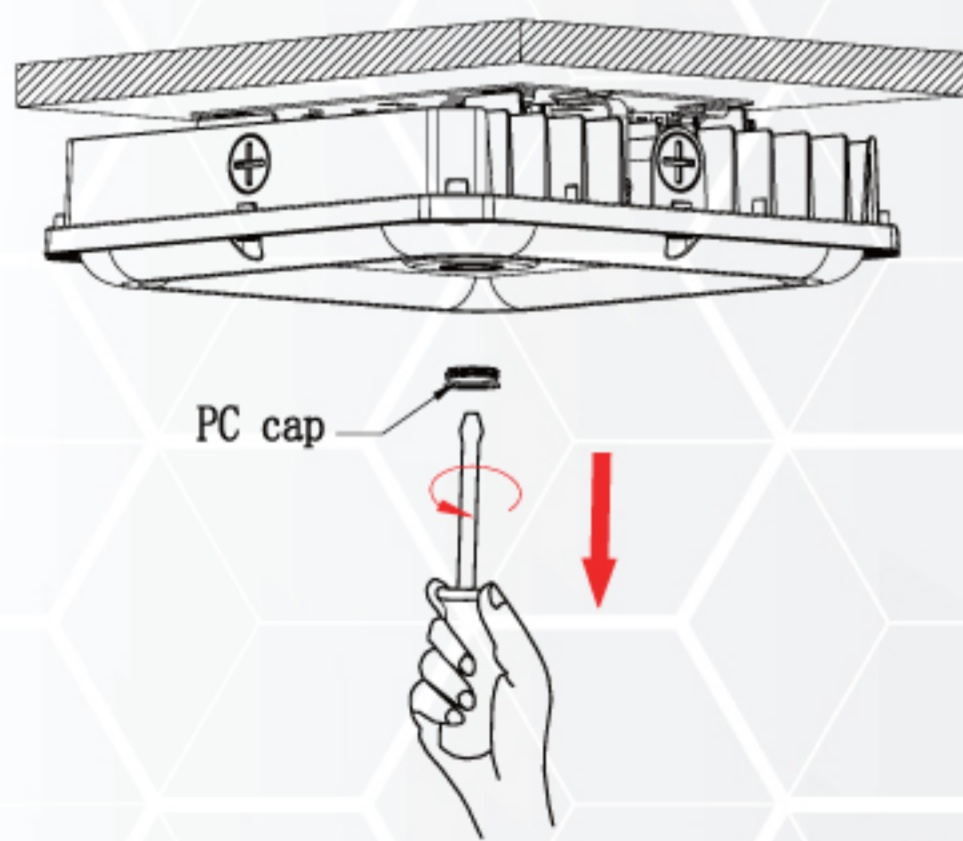

2. Screw the sensor clockwise by hands.

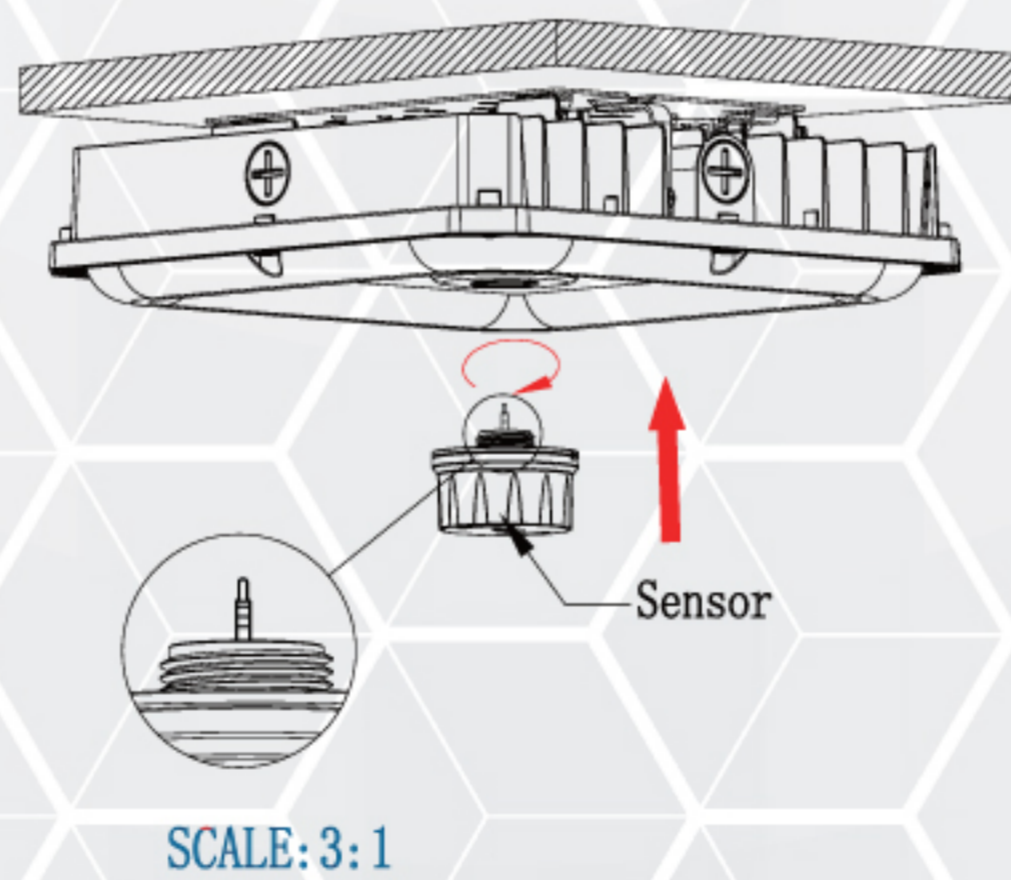

3. After tighten the sensor, Lighting the lamp, if the sensor works well, the installation finish.

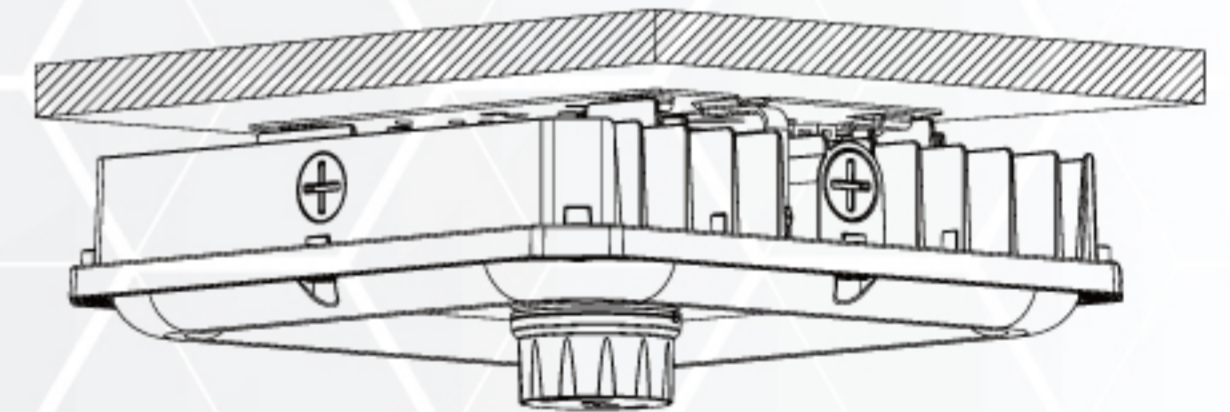

CCT AND POWER SELECTIVE

1. Before installation, unscrew the M25 cap counter-clockwise at the back of the lamp by slot type screwdriver.

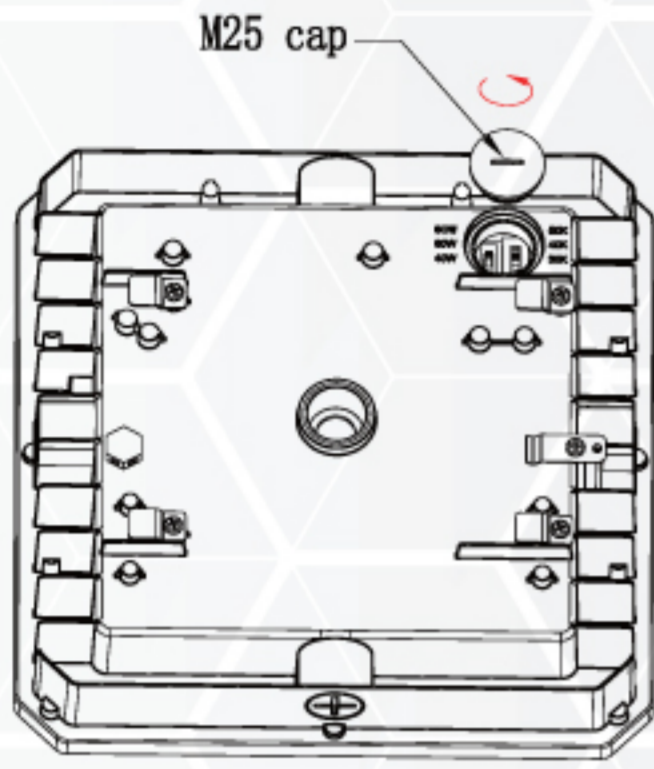

2. According to the tags, customer can select the corresponding power and CCT dip switch, dial to the required power (40w/60w/80w) and CCT (35K/40K/50K).

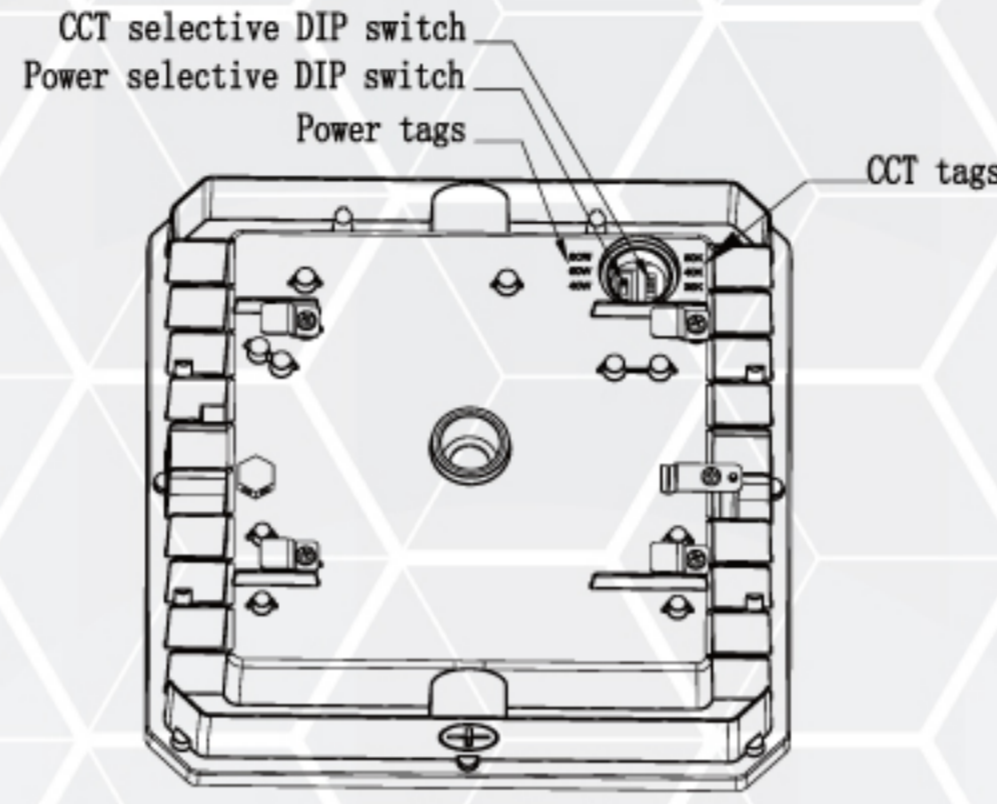

3. After finish the requires power and CCT adjustment, Tighten the M25 cap clockwise by slot type screwdriver.

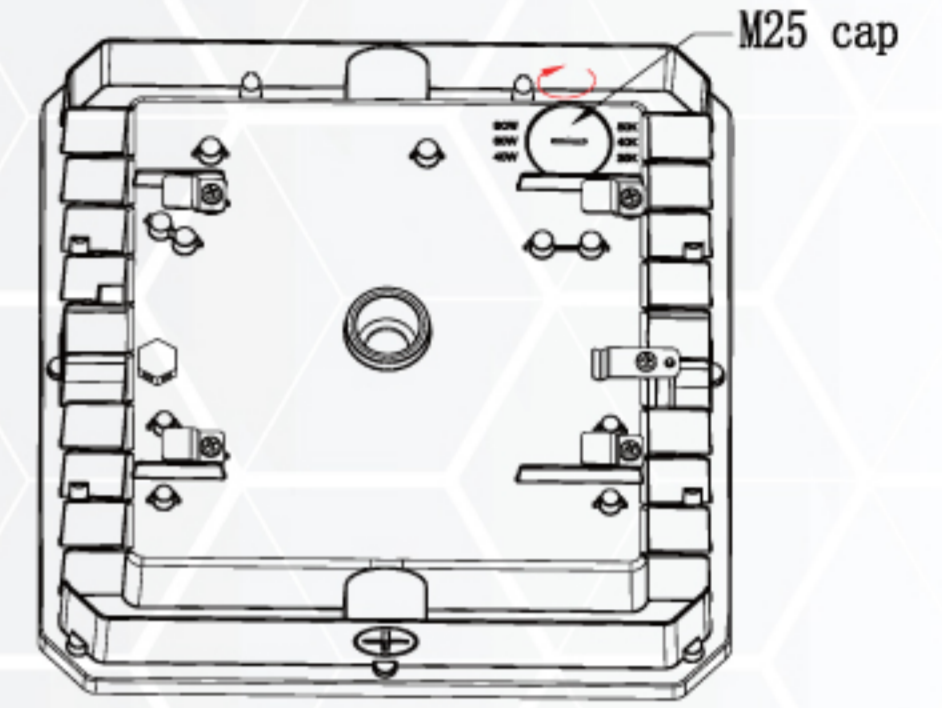

Reference	QTY.	Remarks	Project:
			Location:
			Architect:
			Engineer:
			Contractor:
			Submitted by:
			Date:

ORTECH reserves the right to modify at any time, without notice, any or all of our product's features, designs, components and specifications to meet market changes.