

Mounting Plate

MODEL PLATE6-HB

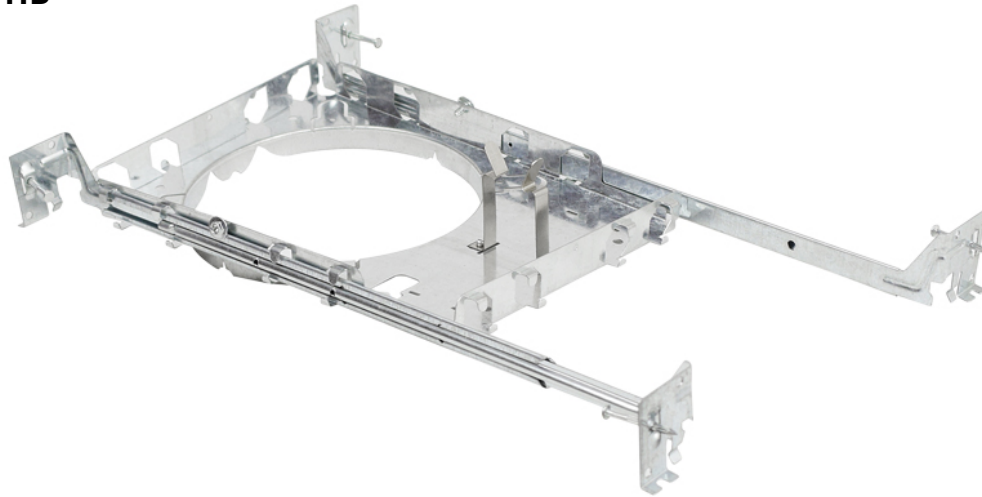

HIGHLIGHTS

Galvanized steel mounting plate with hanger bars for ORTECH 6" LED slim lights

- Hanger bar install in longer side
- For 6" LED slim light with curved lip

SPECIFICATIONS

Model	PLATE6-HB
Hole Size	Ø 6-1/4" (159 mm)
Material	Galvanized steel
Hanger Bar Installation Type	Four way

DIMENSIONS

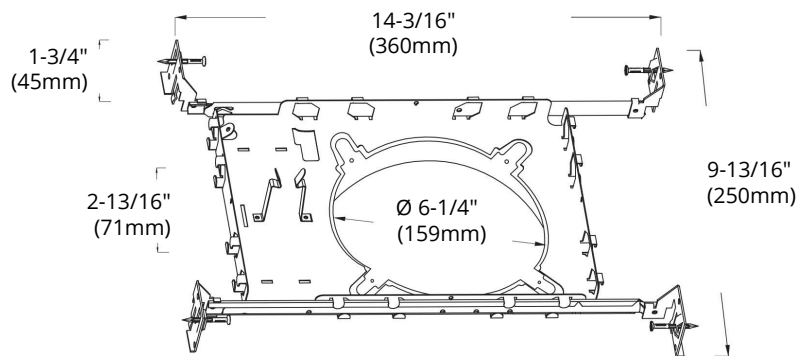

Reference	QTY.	Remarks	Project:
			Location:
			Architect:
			Engineer:
			Contractor:
			Submitted by:
			Date:

ORTECH reserves the right to modify at any time, without notice, any or all of our product's features, designs, components and specifications to meet market changes.