

Mounting Plate

MODEL PLATE3-HB

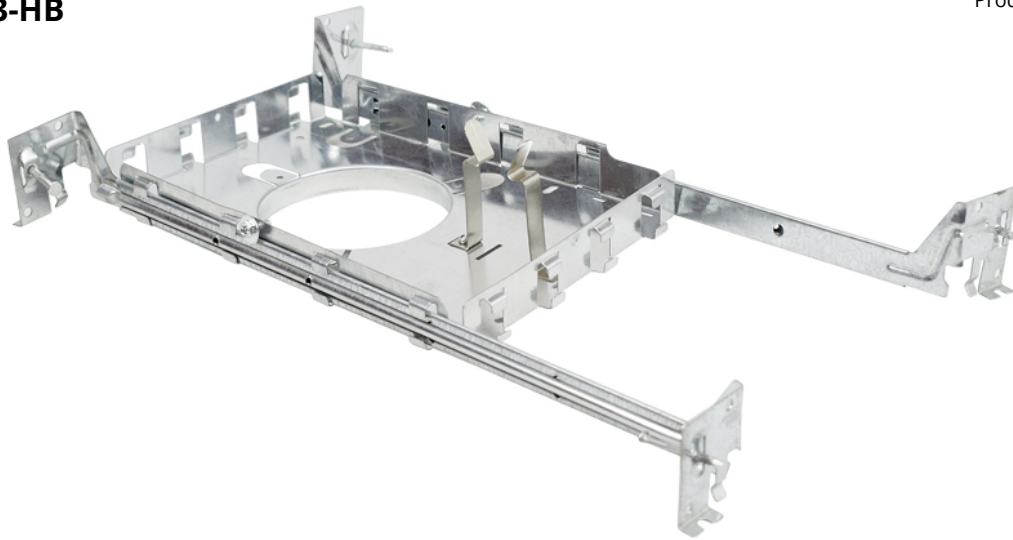

HIGHLIGHTS

Galvanized steel mounting plate with hanger bars for ORTECH 3" LED slim lights

- Hanger bar install in longer side
- For 3" LED slim light with curved lip

SPECIFICATIONS

Model	PLATE3-HB
Hole Size	Ø 3-3/16" (81 mm)
Material	Galvanized steel
Hanger Bar Installation Type	Four way

DIMENSIONS

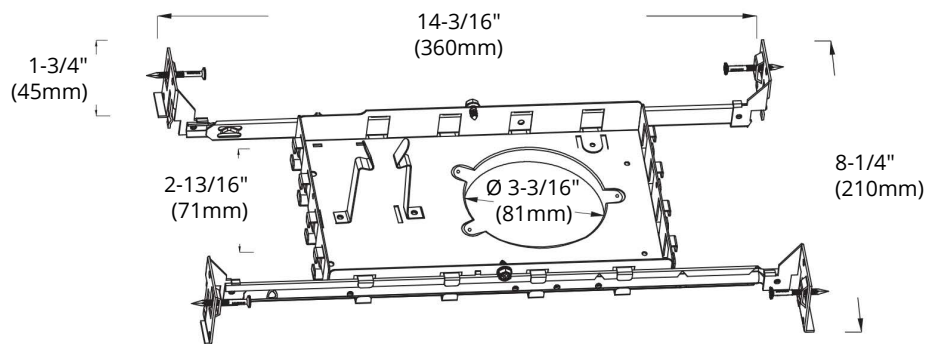

Reference	QTY.	Remarks	Project:
			Location:
			Architect:
			Engineer:
			Contractor:
			Submitted by:
			Date:

ORTECH reserves the right to modify at any time, without notice, any or all of our product's features, designs, components and specifications to meet market changes.